

SETUP INSTRUCTIONS

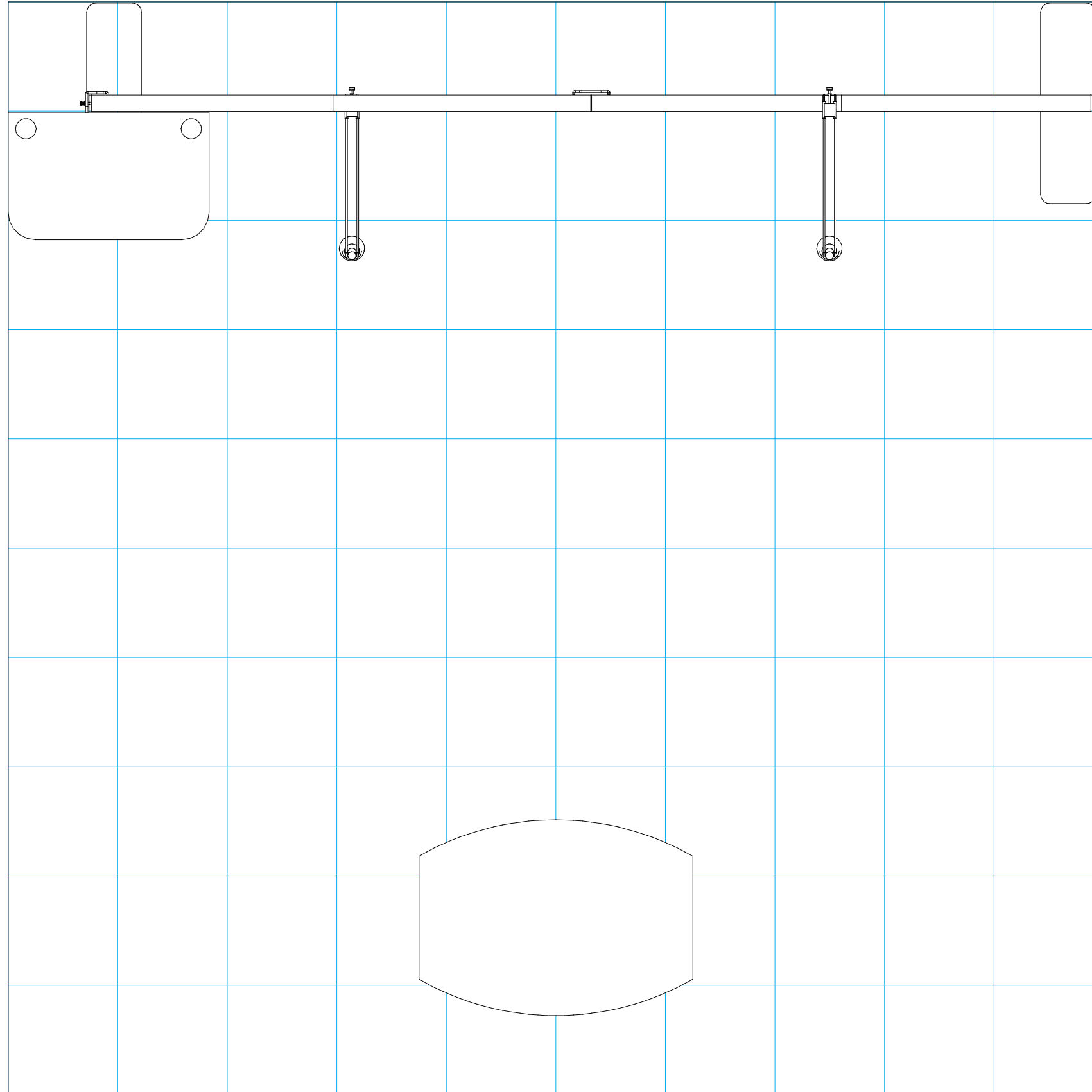

= 1 sq ft

General Setup Instructions

- Read entire setup instruction manual prior to unpacking parts and pieces.
- The setup instructions are created specifically for this configuration.
- Setup instructions are laid out sequentially in steps, including exploded views with detailed explanation for assembly.



Part Identification - Numbering

Cleaning & Packing

- For Cleaning Metal, Plex, & Laminate Parts: Use a **MILD NON-ABRASIVE** cleanser and soft cloth/paper towel to clean all surfaces.
- Keep exhibit components away from heat and prolonged sun exposure.
Heat and UV exposure will warp and fade components.
- Retain all provided Packing Materials. All provided packing materials are for ease of repacking & component protection.



Engaged Lock



WARNING



DO NOT USE POWER TOOLS



ALL CONNECTIONS MUST BE TIGHTLY SECURED

Disassembly

- For loss prevention, keep all knobs & connectors attached to extrusions during disassembly.

Straight Connection

When assembling frame, first attach all **straight connectors**, then attach **corner connectors**.

- 1) Place extrusions end-to-end.
- 2) Loosen all knobs, then slide **straight connector** across the seam of extrusions.
- 3) Tighten all knobs to secure connection.

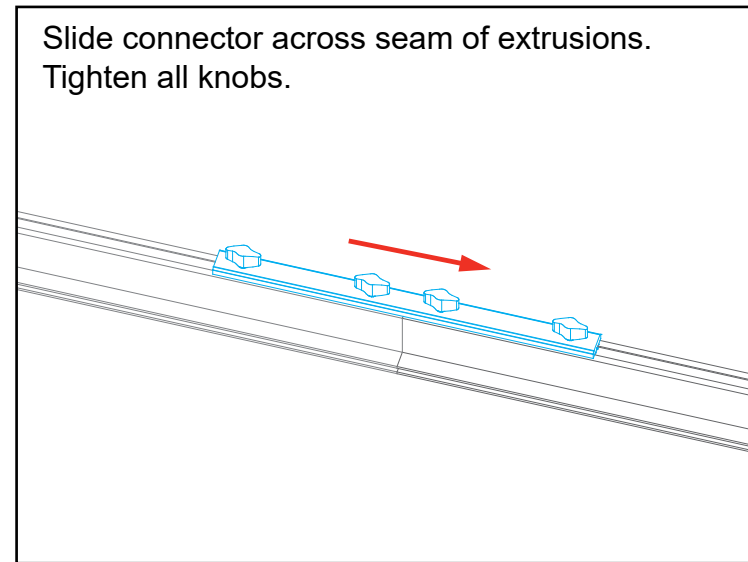
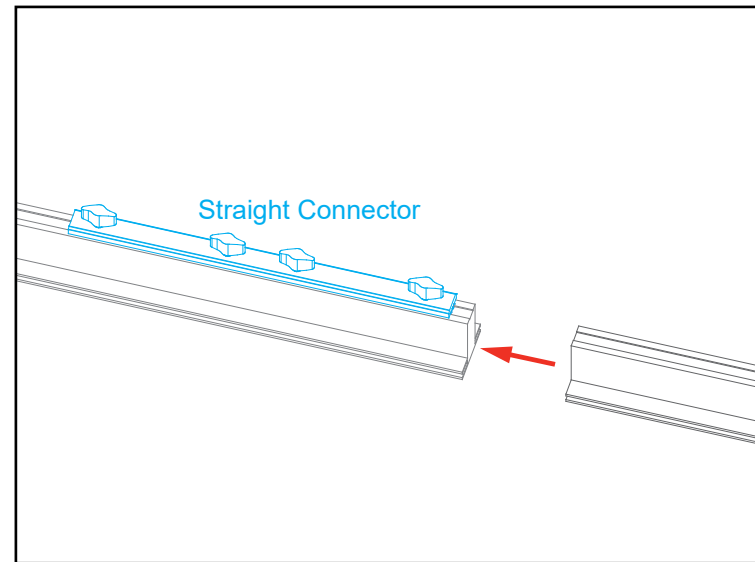

Disassembly

- 1) Loosen all knobs.
- 2) Slide connectors off of one extrusion.
- 3) Tighten knobs to prevent loss during packing & shipping.

Keep straight connectors in groove of extrusion. Do not remove connectors during disassembly.

All knobs must be tightened securely to ensure a proper connection.

Corner Connection

- 1) Loosen knobs, then slide vertical extrusions onto **corner connectors** of **lower** horizontal extrusion.
- 2) Slide **corner connectors** of **upper** horizontal extrusion into grooves of vertical extrusions.
- 3) Tighten all knobs to secure connection.

Disassembly

- 1) Loosen knobs on vertical extrusions.
- 2) Slide the vertical extrusions off of **corner connectors** on lower and upper horizontal extrusions.

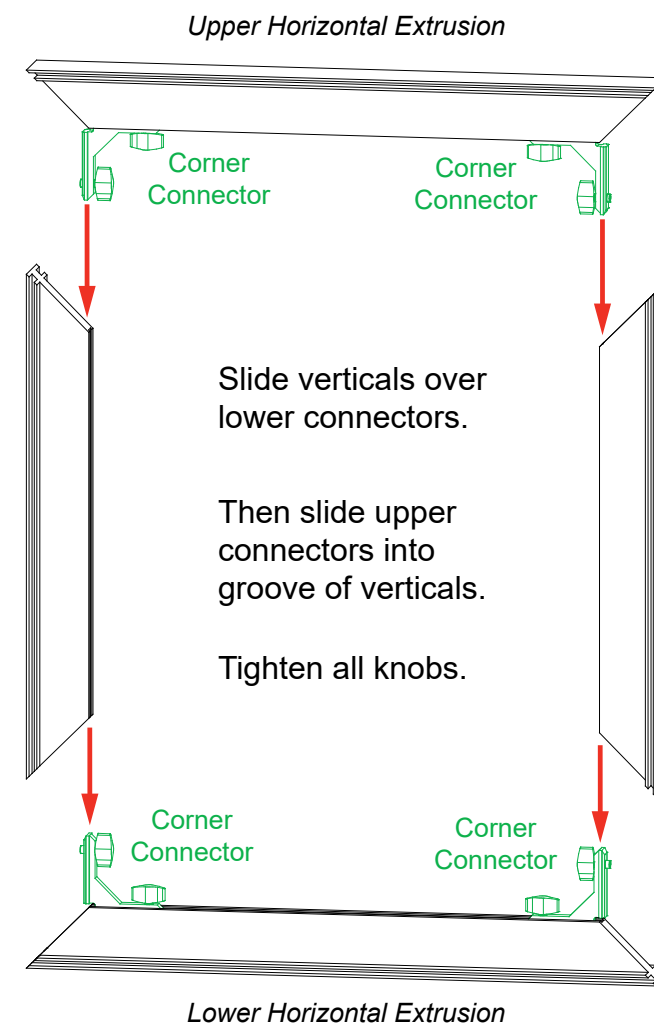

Adjust connectors if necessary to prevent gaps in connection.

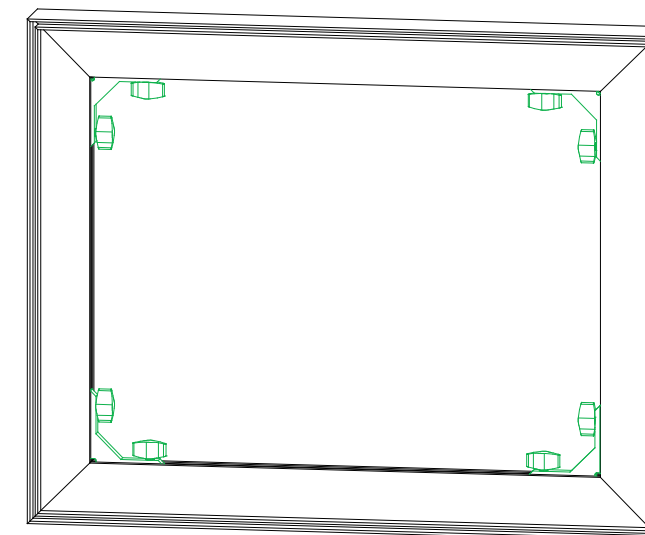

COMPLETED ASSEMBLY

All knobs must be tightened securely to ensure a proper connection.

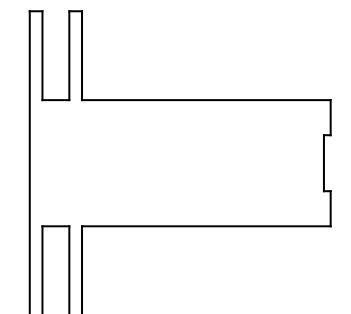

TSP49 Profile

The Perfect Fit

SEG Graphic Installation in 3 Steps

STEP 1: Attach Corners



STEP 2: Attach Middle



STEP 3: Attach Sides



Insert narrow side of silicone welt into the channel at corner 1, with fabric to the outside.

Repeat for opposite corner 2, then corner 3, then corner 4.

Once corners are attached, press the middle of edge 1 into the channel. Then press middle of edge 2 into the channel on opposite side.

Repeat with edge 3 & 4.

Once the middle of sides are attached, fully press the silicone welt into the channel, between center and corner at location 1. Repeat the process between center and corner at location 2.

Do the same for welt on opposite side, at locations 3 & 4. Then repeat for locations 5 & 6 and 7 & 8.

Once the welt is fully inserted on all sides, smooth out edges as needed for a perfect fit.



To remove the graphic from the frame, locate the fabric **pull tab**. Gently pull on the tab to remove the graphic.

Install video:



Top View of Each Level

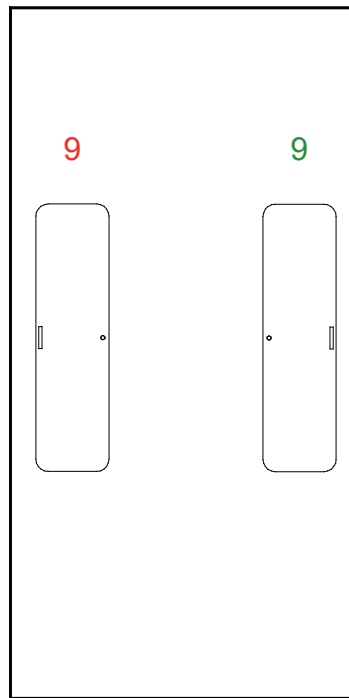

Level 1
(Bottom level)

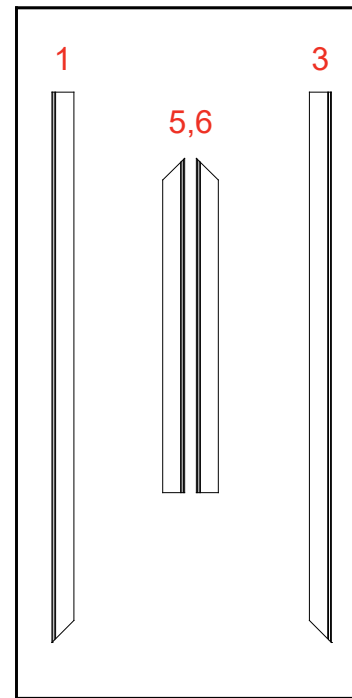

Level 2

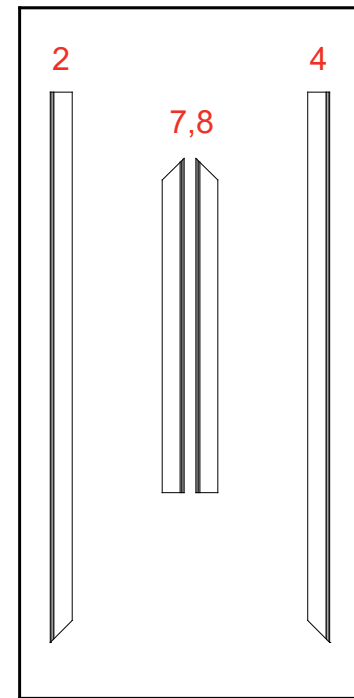

Level 3

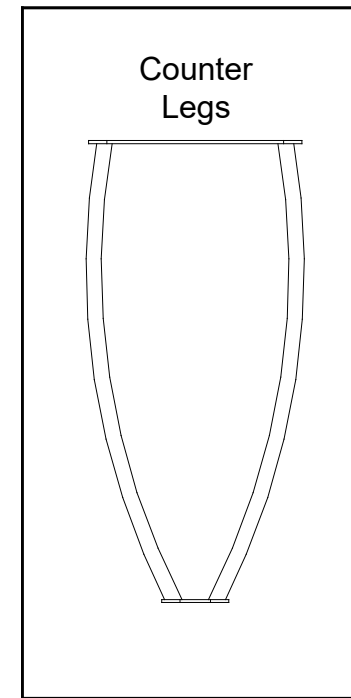

Level 4

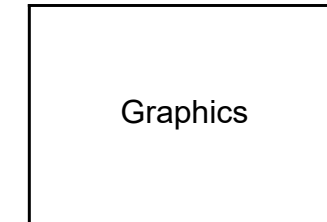

Top View of Each Level

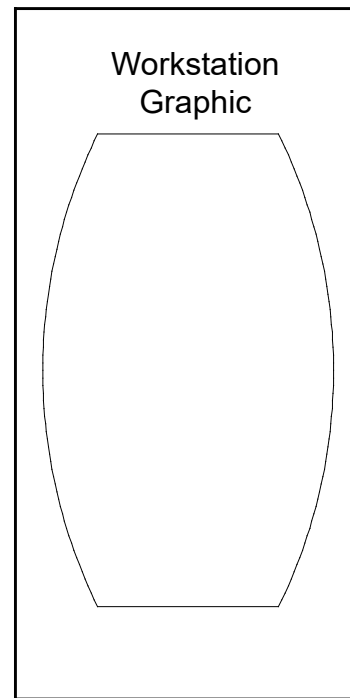

Level 1
(Bottom level)

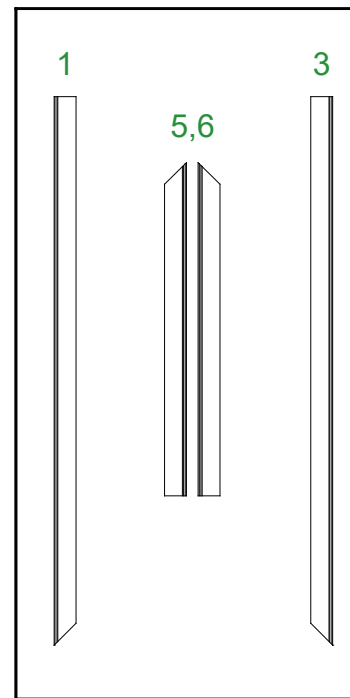

Level 2

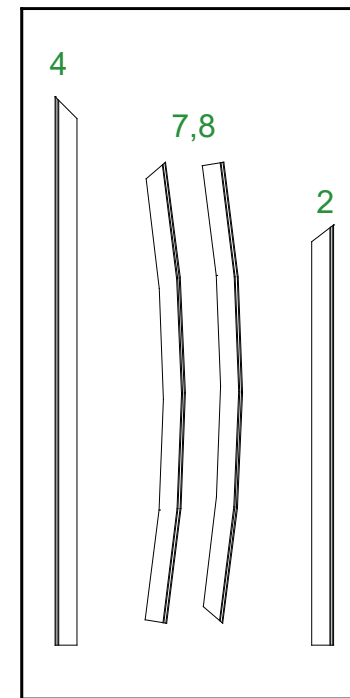

Level 3

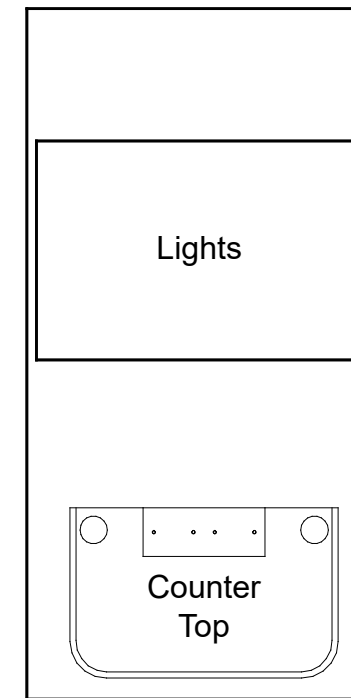

Level 4

Top View of Each Level

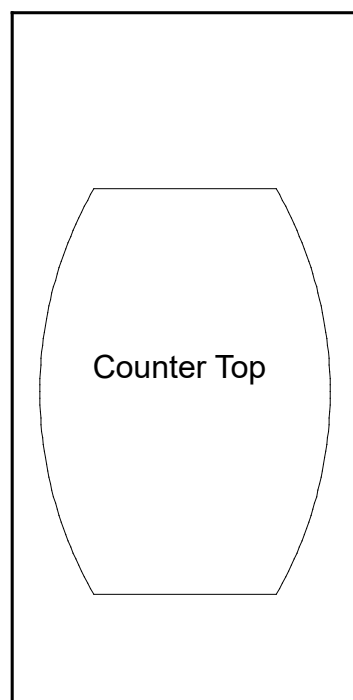

Level 1
(Bottom level)

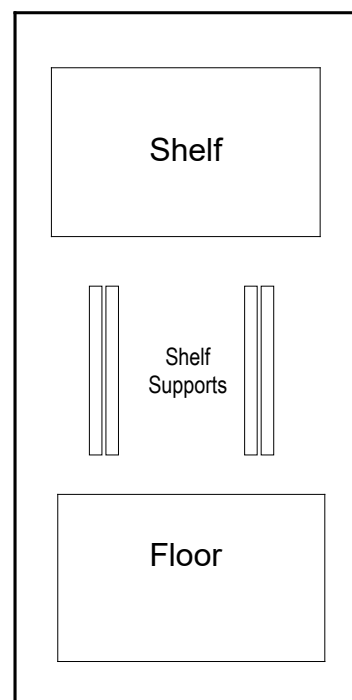

Level 2

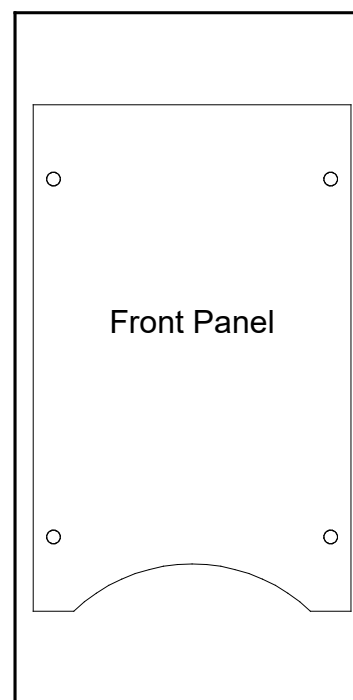

Level 3

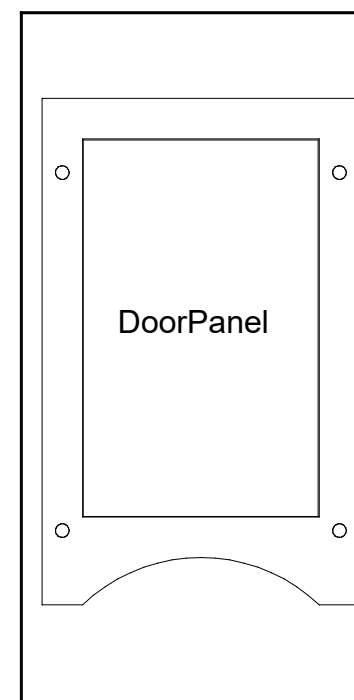

Level 4

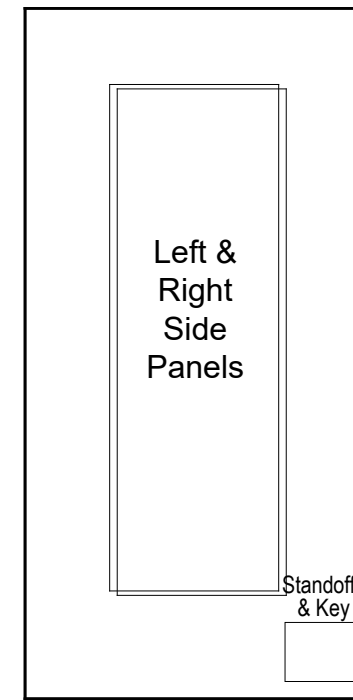

Level 5

Item	Qty.	Description
1	1	45"h TSP49 Vertical Extrusion
2	1	31.305"h TSP49 Vertical Extrusion
3	1	45"h TSP49 Vertical Extrusion
4	1	45"h TSP49 Vertical Extrusion
5	1	27.35"w TSP49 Horizontal Extrusion
6	1	27.35"w TSP49 Horizontal Extrusion
7	1	28.514"w TSP49 curved Horizontal Extrusion
8	1	28.514"w TSP49 curved Horizontal Extrusion
9	1	6" x 22" End Base Plate w/ foot

Steps:

Refer to the Tool-less Frame Assembly general information page.

- 1) Assemble vertical extrusions [1-2], [3-4] & horizontal extrusions [5-6], [7-8] together, using Tool-less Spline connectors labeled [X] & [Y].
- 2) Connect vertical assemblies [1/2], [3/4] between horizontal assemblies [5/6], [7/8], using Tool-less Corner Connectors labeled [A] & [B].
- 3) Install Base Plate [9] to bottom corners of frame assembly as shown. See Base Plate Attachment detail.

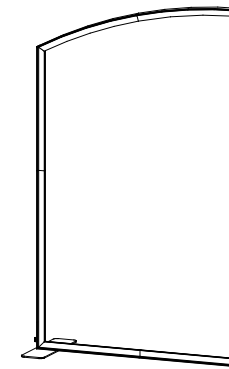

When assembled

Assemble frame flat on ground.

*** Tool-less Spline Connector**

1. Place extrusions end-to-end.

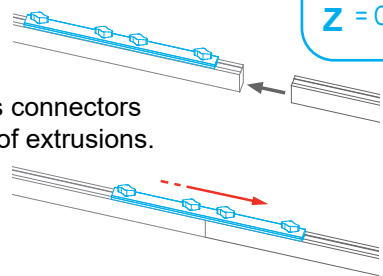

- X = Straight spline
- Z = Curved spline

2. Slide tool-less connectors across seam of extrusions.

3. Tighten all knobs to secure connection.

*** Tool-less Corner Connector**

1. Slide extrusion onto Corner Connector.
2. Tighten all knobs to secure connection.

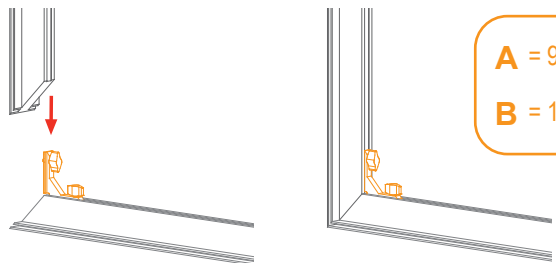

- A = 90° Connector
- B = 117° Connector

Keep corner connectors attached to horizontal extrusions.

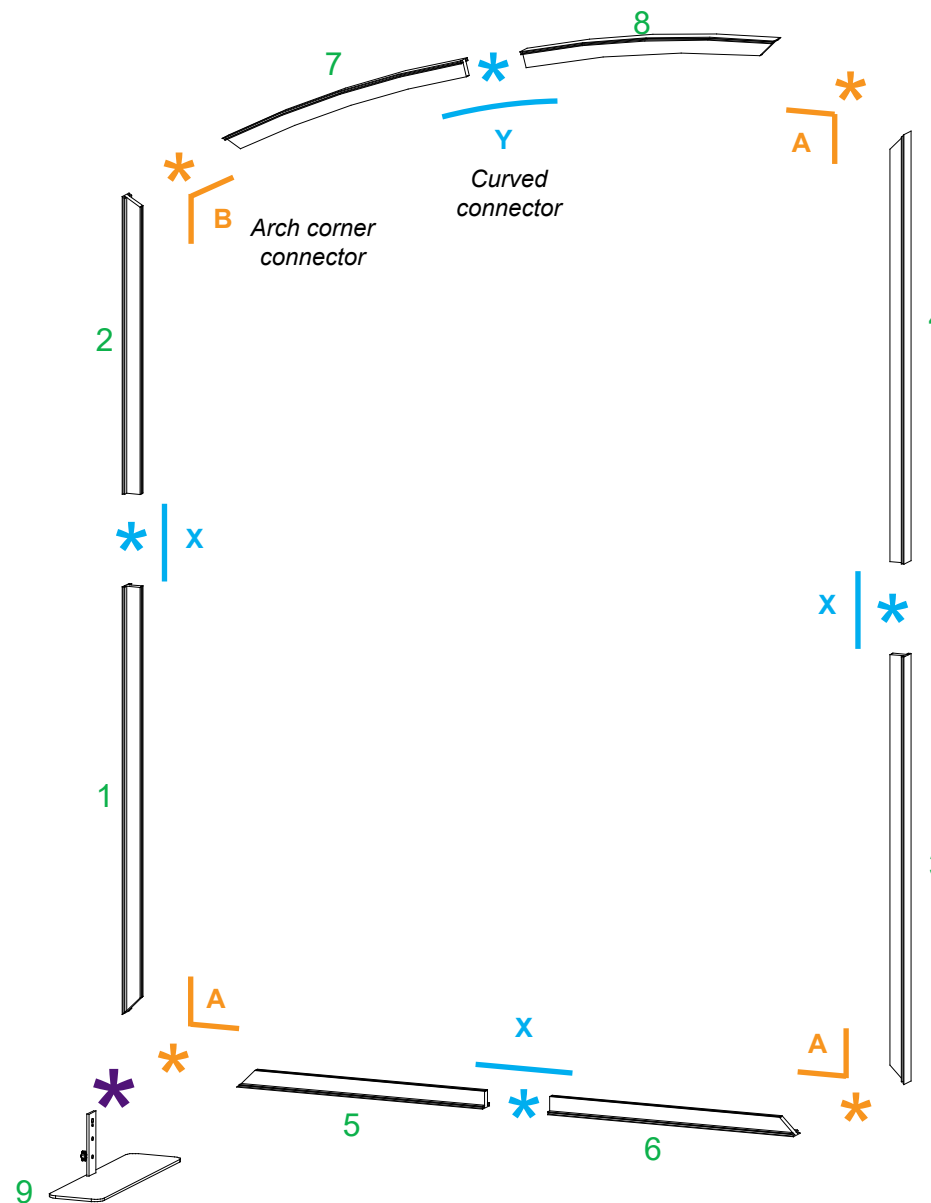

FRONT VIEW

*** Base Plate Attachment**

- 1) Place key hole over bolt on panel & slide down.
- 2) Twist knob to secure connection.

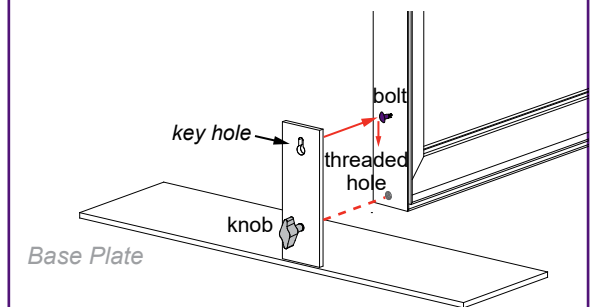

Item	Qty.	Description
1	1	45"h TSP49 Vertical Extrusion
2	1	45"h TSP49 Vertical Extrusion
3	1	45"h TSP49 Vertical Extrusion
4	1	45"h TSP49 Vertical Extrusion
5	1	27.35"w TSP49 Horizontal Extrusion
6	1	27.35"w TSP49 Horizontal Extrusion
7	1	27.35"w TSP49 Horizontal Extrusion
8	1	27.35"w TSP49 Horizontal Extrusion
9	1	6" x 22" End Base Plate w/ foot

Steps:

Refer to the *Tool-less Frame Assembly* general information page.

- 1) Assemble vertical extrusions [1-2], [3-4] & horizontal extrusions [5-6], [7-8] together, using **Tool-less Spline connectors** labeled [X].
- 2) Connect vertical assemblies [1/2], [3/4] between horizontal assemblies [5/6], [7/8], using **Tool-less Corner Connectors** labeled [A].
- 3) Install Base Plate [9] to bottom corners of frame assembly as shown. See **Base Plate Attachment** detail.

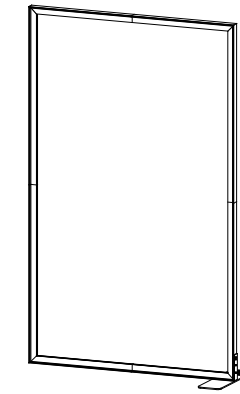

When assembled

Assemble frame flat on ground.

*** Tool-less Spline Connector**

1. Place extrusions end-to-end.

X = Straight spline

2. Slide tool-less connectors across seam of extrusions.

3. Tighten all knobs to secure connection.

*** Tool-less Corner Connector**

1. Slide extrusion onto Corner Connector.
2. Tighten all knobs to secure connection.

A = 90° Connector

Keep corner connectors attached to horizontal extrusions.

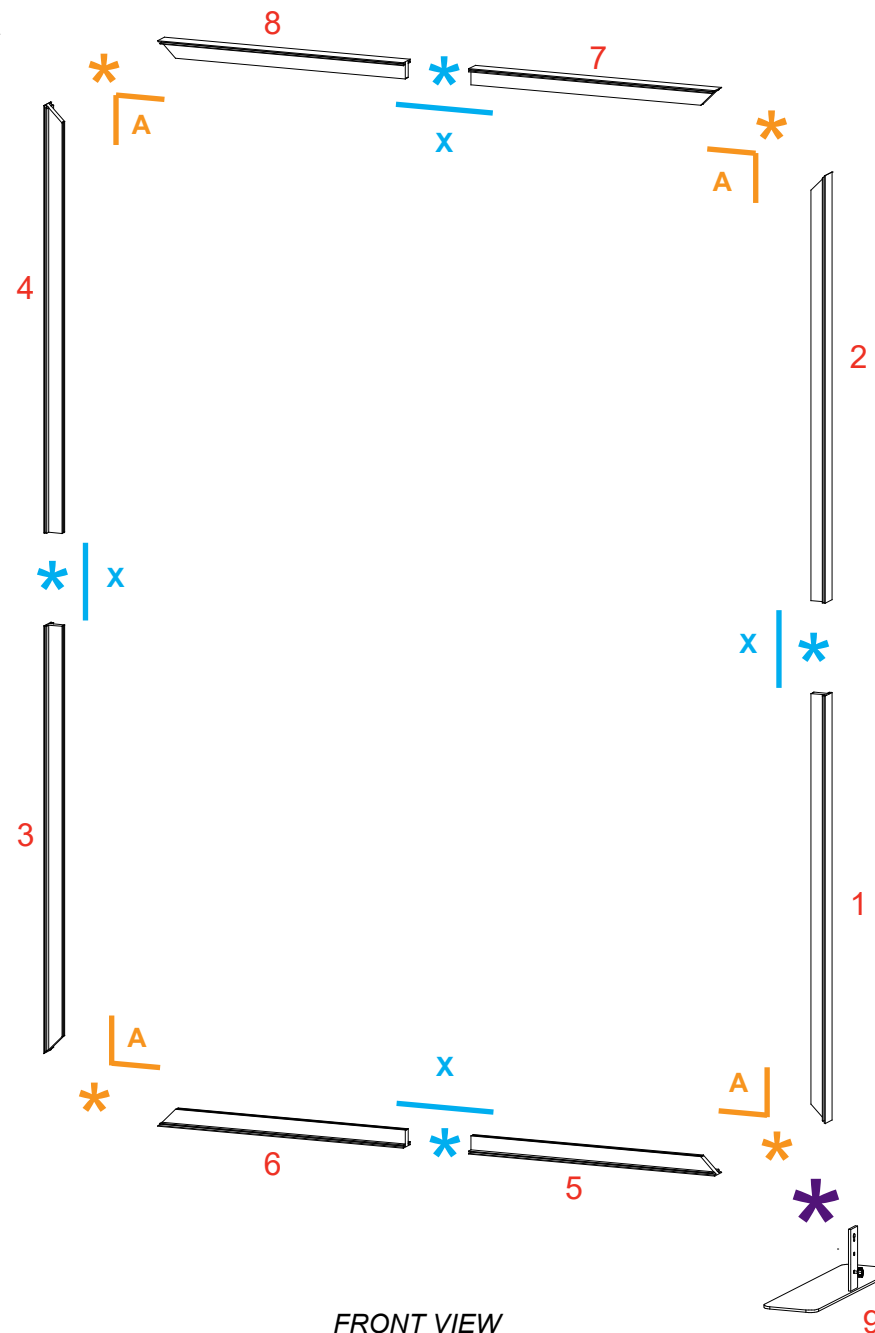

*** Base Plate Attachment**

- 1) Place key hole over bolt on panel & slide down.
- 2) Twist knob to secure connection.

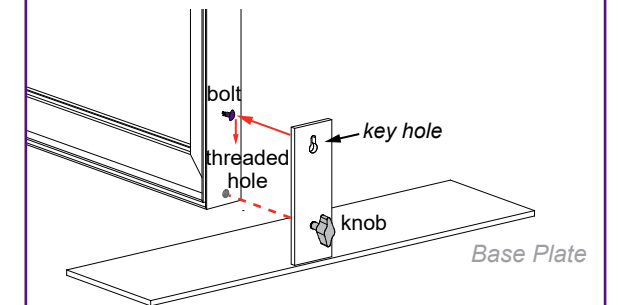

* Frame Connection

① From back side of display, slide U-Shaped Clamp forward then down onto V4 connectors on left & right frames.

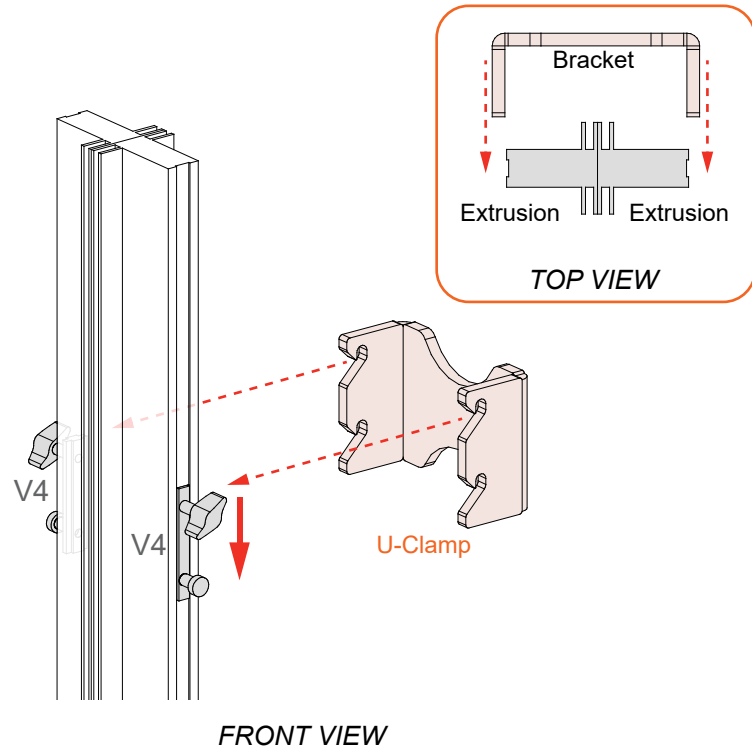

② Tighten knobs of V4 connectors to secure Clamp in place.

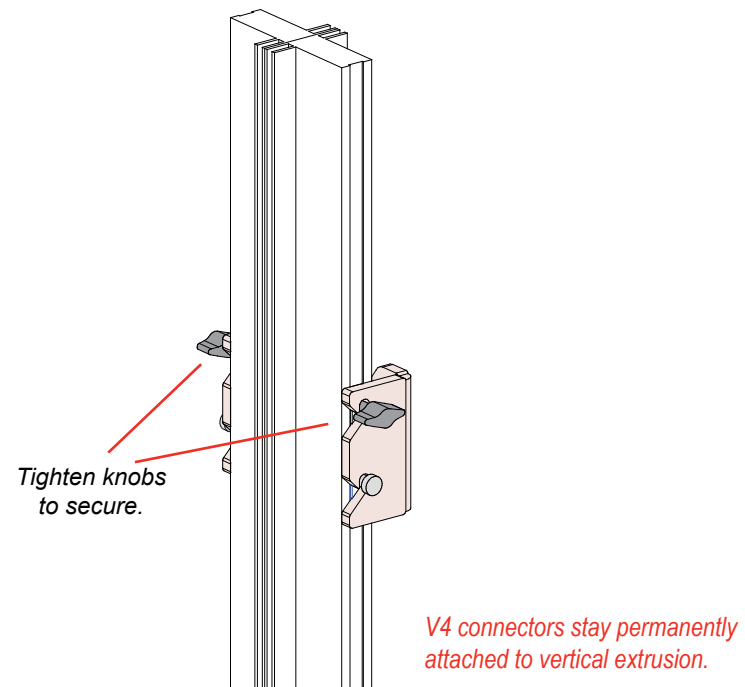

Steps:
1) Connect left & right frames together using U-Shaped Clamps.
See **Frame Connection** detail.

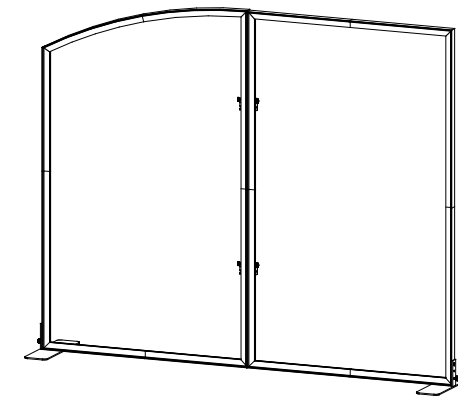

When assembled

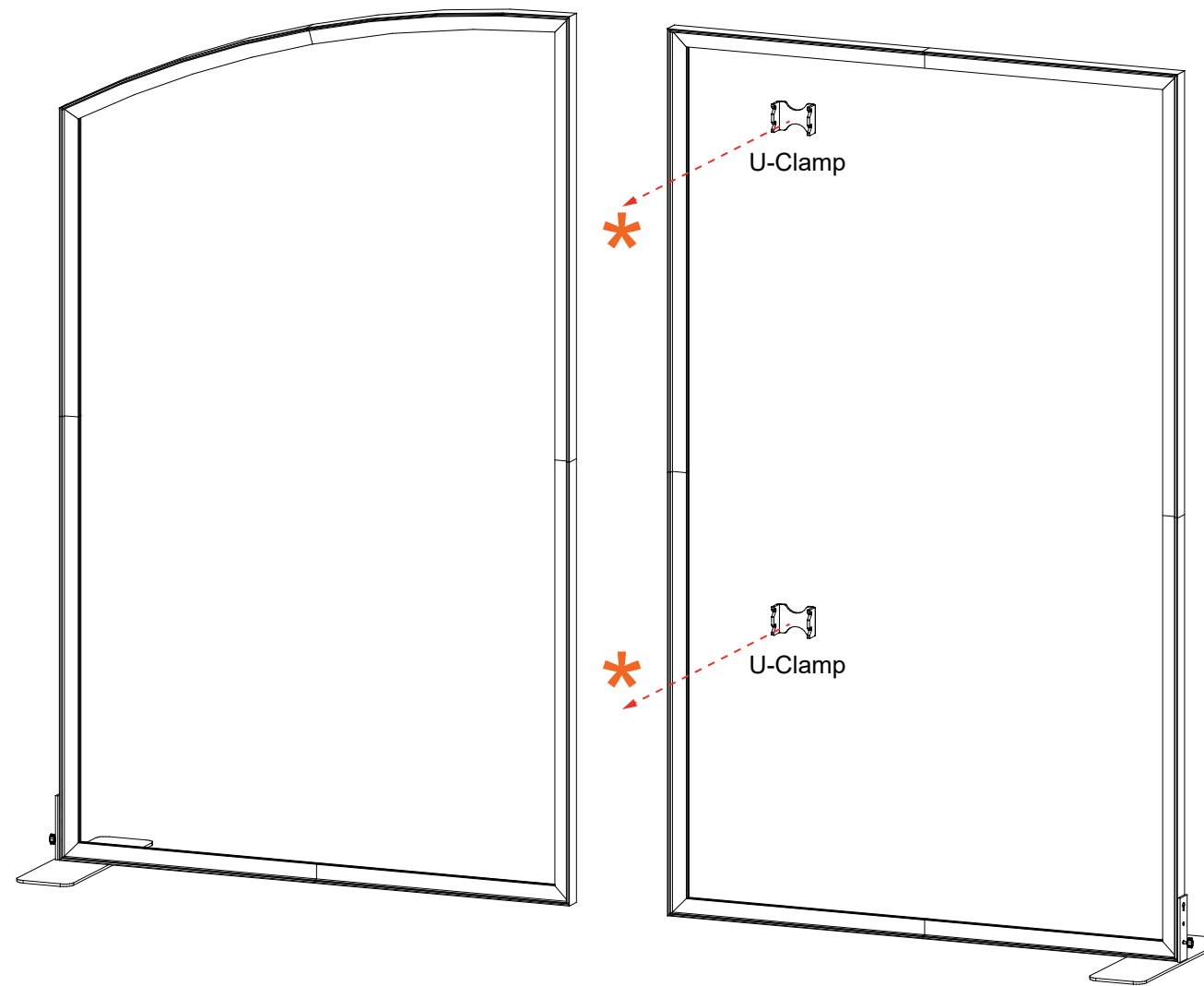

FRONT VIEW

SEG Graphic Installation

STEP 1: Attach Corners

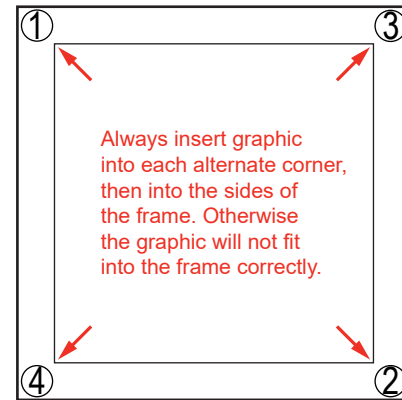

Insert narrow side of silicone welt into the channel at corner 1, with fabric to the outside.

Repeat for opposite corner 2, then corner 3, then corner 4.



STEP 2: Attach Middle

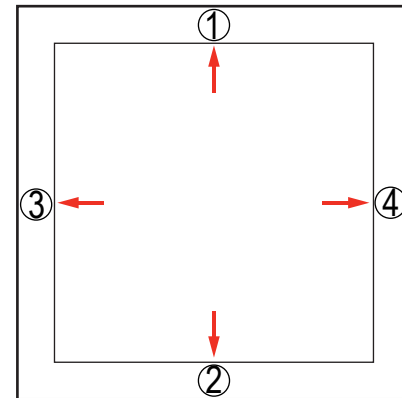

Once corners are attached, press the middle of edge 1 into the channel. Then press middle of edge 2 into the channel on opposite side.

Repeat with edge 3 & 4.

STEP 3: Attach Sides

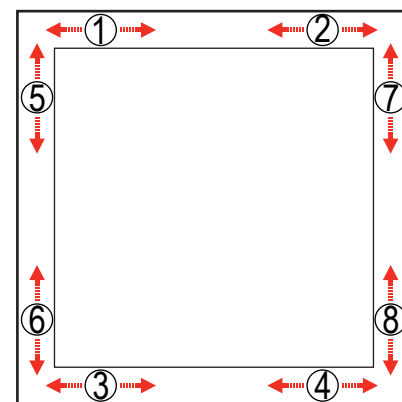

Once the middle of sides are attached, fully press the silicone welt into the channel, between center and corner at location 1. Repeat the process between center and corner at location 2.



Do the same for welt on opposite side, at locations 3 & 4. Then repeat for locations 5 & 6 and 7 & 8.

Steps:

1) Apply SEG Graphics to front of assembled frames.

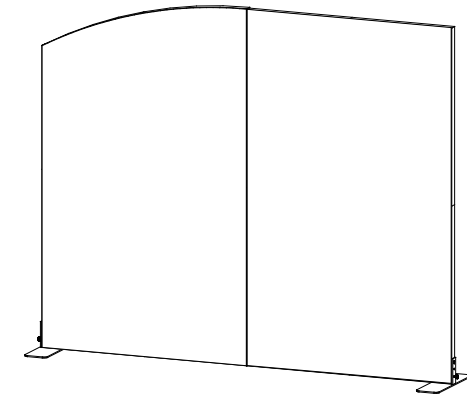

When assembled

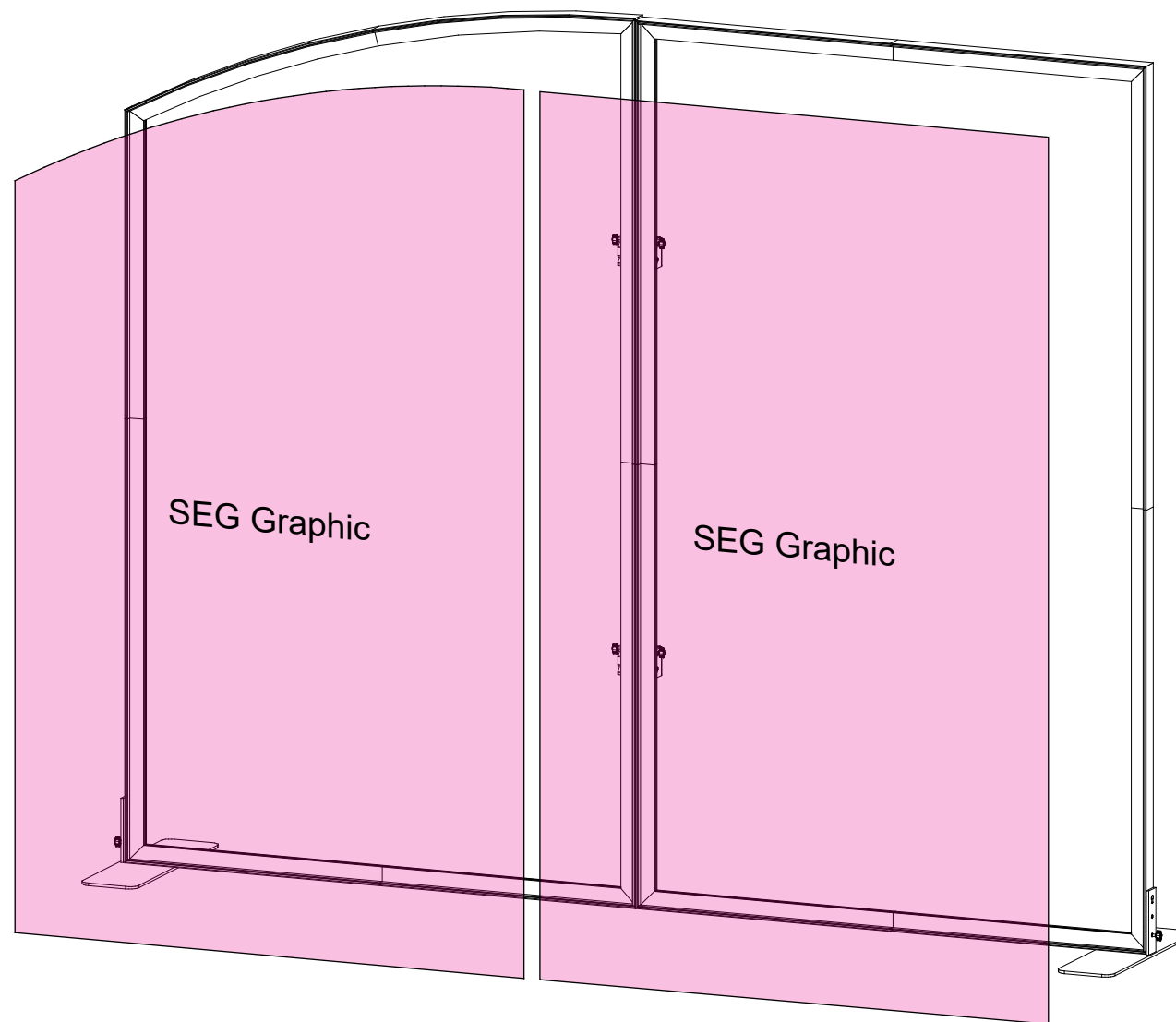

FRONT VIEW

* Workstation Bracket Attachment

1) Hook the Mounting Bracket over the vertical extrusion.

2) Slide bracket forward, then down onto V4 connector.

V4 connectors stay permanently attached to vertical extrusion.

3) Tighten thumb screws to secure connection to inside of frame.

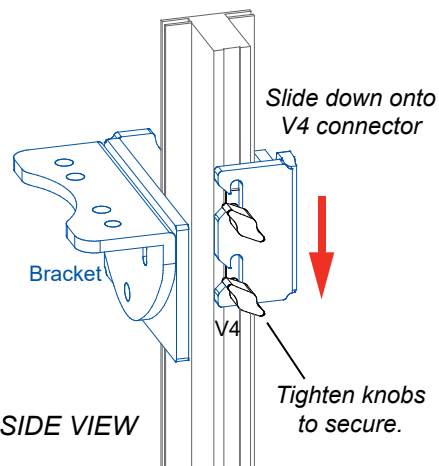
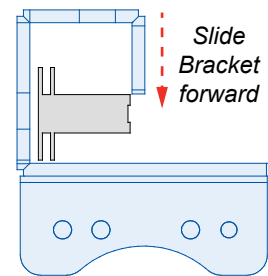
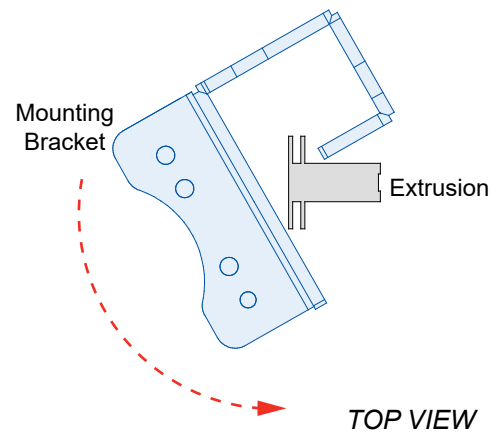

Steps:

- 1) Attach Workstation Mounting Bracket to backwall vertical as shown. See [Workstation Bracket Attachment](#) detail.
- 2) Assemble Workstation legs & counter top to bracket. See [Workstation Assembly](#) detail.
- 3) Affix **Graphic** to front of workstation assembly, using Velcro.
- 4) Attach Lights to top of backwall as shown. See [Light Attachment](#) detail.

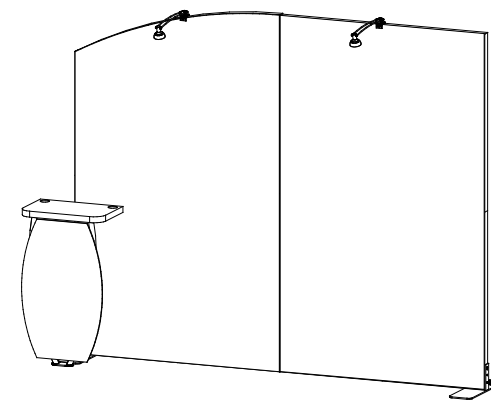

Completed Assembly

Workstation Assembly

1) Attach threaded studs on underside of Counter Top to Counter Legs; secure with wing nuts.

2) Connect Counter Top to Mounting Bracket, using wing nuts.

3) Attach power cords to wireless chargers.

Keep cords attached to underside of counter top.

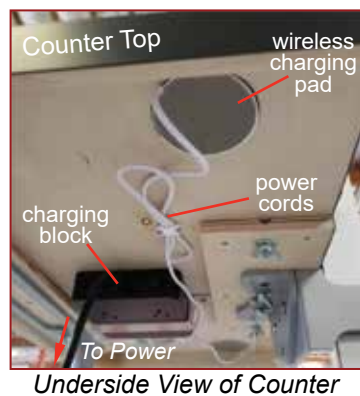
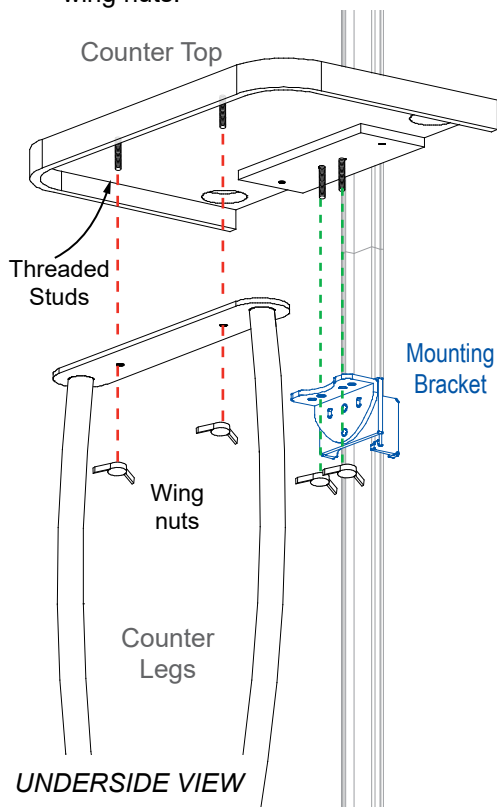

* Light Attachment

Attach clamp of stem light to top of horizontal extrusion where desired.

Twist knob on back to tighten in place.

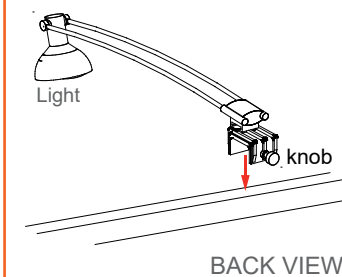

Workstation

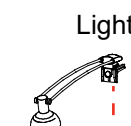
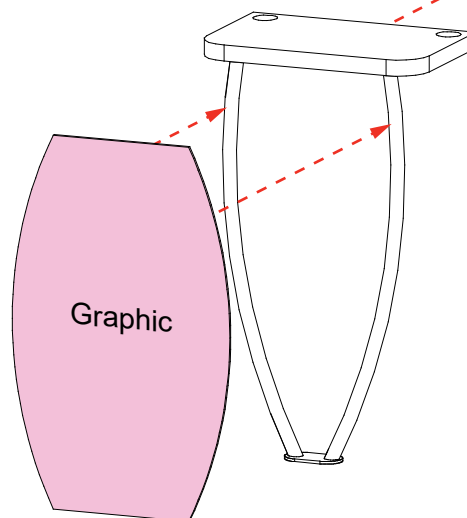

Steps:

- 1) Attach pins at bottom interior of side panels. *Note: Pins are designed to be slightly angled.*
- 2) Use screw caps to secure side panels to front & back panels.
- 3) Slide floor into the bottom of assembled pedestal base. The floor will sit on pins of the side panels.
- 4) Connect shelf supports with Velcro inside of panels, then place shelf on top of supports.
- 5) Attach Counter Top to assembled pedestal base. See Counter Top Attachment detail.

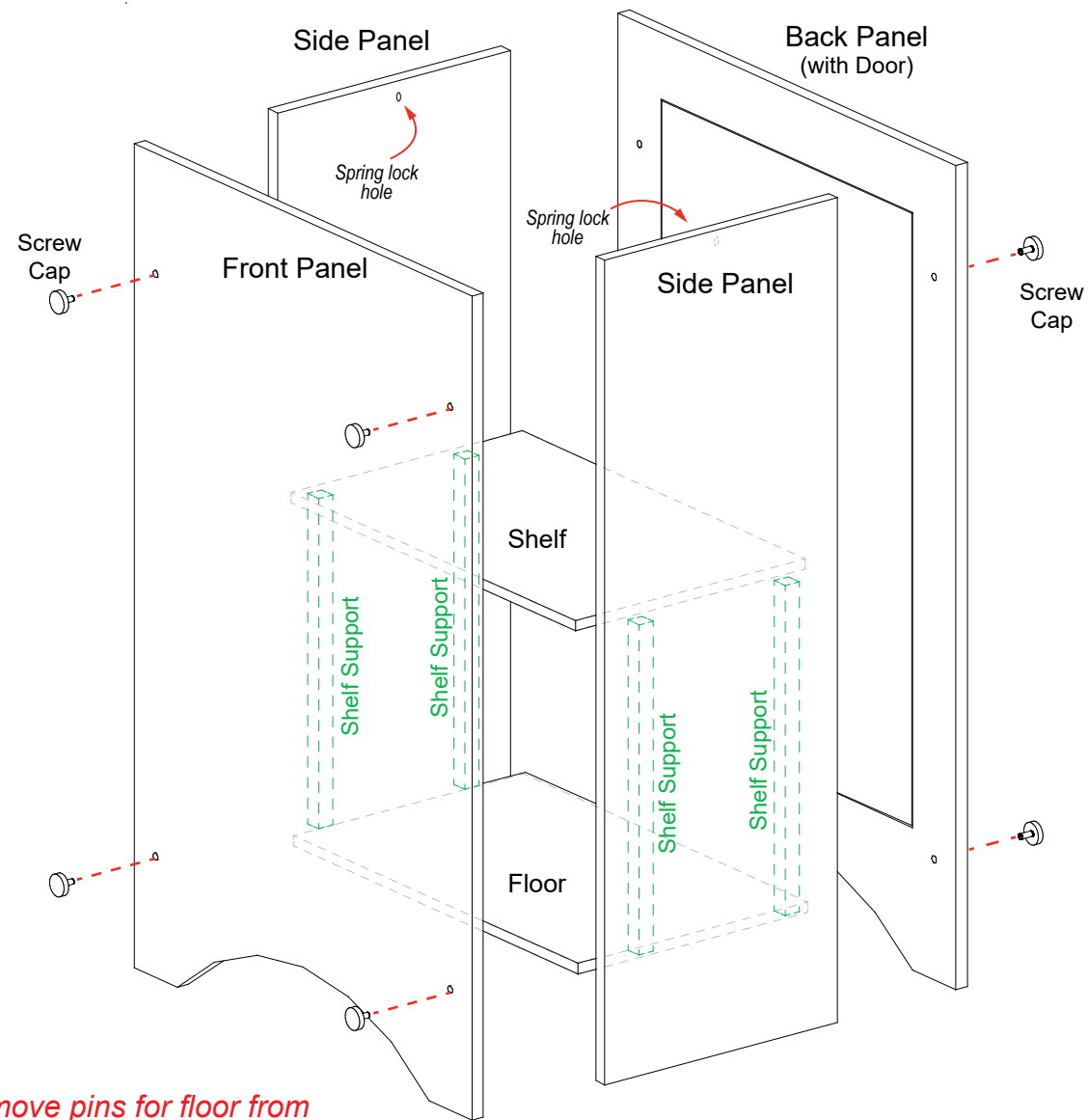

Pedestal Base Assembly

NOTE: Remove pins for floor from side panels when packing.

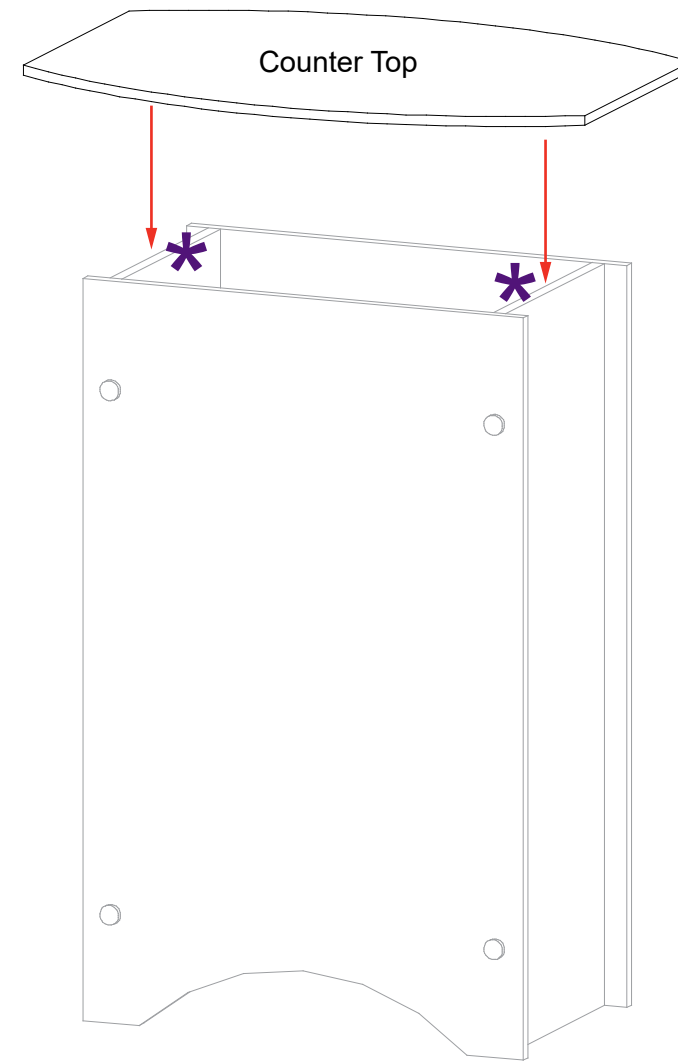

Pedestal Top Attachment

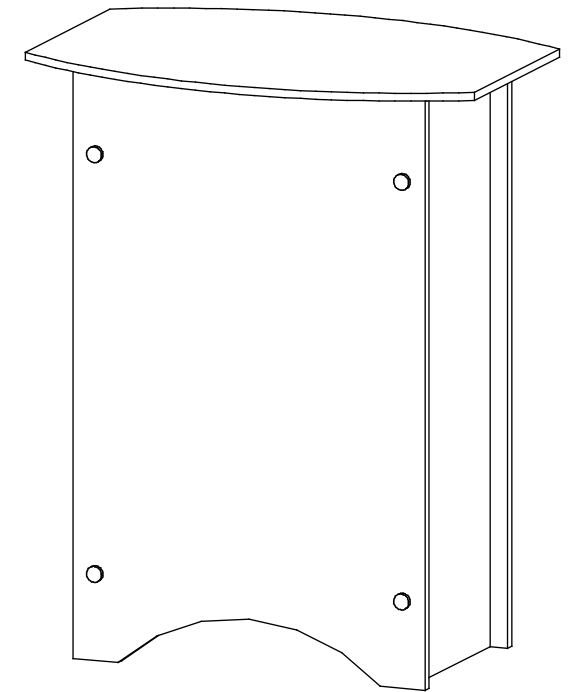

When assembled

